

# Honeywell Security

HELLO PHONE Smile reaches your heart



## Honeywell Hello Series Video Door Phone System Product Catalog

For more information:

Asia Pacific Headquarters:  
Australia  
China  
Hong Kong

Tel: (86) 21-5257 4568  
Tel: (61) 2-8837 9300  
Tel: (86) 755-2518 1226  
Tel: (852) 2405 2323

India  
Korea  
Singapore  
Taiwan

Tel: (91) 124 4105671  
Tel: (82) 2-799 6130  
Tel: (65) 6333 9563  
Tel: (886) 2-2245 1000

[www.asia.security.honeywell.com](http://www.asia.security.honeywell.com)  
[security.ap@honeywell.com](mailto:security.ap@honeywell.com)

Automation & Control Solutions  
Honeywell Security - Asia Pacific  
Honeywell International Inc.  
[www.security.honeywell.com](http://www.security.honeywell.com)

Mar 2008  
© 2008 Honeywell International Inc.

**Honeywell**

HELLO PHONE Smile reaches your heart

**Honeywell**

# Honeywell Security, Your Partner of Choice!



Ranking among Fortune Top 100 companies, Honeywell International is a diversified technology and manufacturing leader. Our areas of business cover various industries representing by our four strategic business groups: Aerospace, Automation and Control Solutions (ACS), Transportation Systems and Specialty Materials.

Today we employ more than 5,000 employees in various cities in China and a total over 120,000 employees in more than 100 countries worldwide.



Commitment

Constant Innovation

Support and the Best People

The Power of Honeywell

*At Honeywell, security holds a very special place in our portfolio. It is core to our mission of protecting communities and making the world safer. In fact, during the past few years, about 25% of what we have invested in strategic acquisitions has been used to enhance our security business. We want to be your partner of choice in the security business.*

*Dave Cote  
Chairman and CEO, Honeywell*

## Honeywell Security

Honeywell Security is a business unit of Honeywell International's Automation and Control Solutions group (ACS), a leading global supplier of electronic security systems and components for residential, commercial, industrial and governmental applications.

Honeywell International (NYSE: HON) is a \$37 billion diversified technology and manufacturing leader based in Morris Township, N.J. Honeywell shares are traded on the New York, London and Chicago Stock Exchanges.

### Honeywell Security prides itself on being the partner of choice for its customers through:

**Commitment:** Honeywell is committed to the security business and in serving end-users through leading dealers, integrators and distributors worldwide. Making People Safer and Secure is part of Honeywell's brand promise.

developed by Honeywell Labs, advanced sensors from the Sensing and Control business or GPS systems from Aerospace.

**Constant Innovation:** Honeywell has an extraordinary range of solutions across intruder, video surveillance and access control technologies, and invests over \$100 million a year in research and development. Honeywell Security has engineering centers of excellence in the U.S., Canada, China, Korea, India, Scotland and France, and leverages technologies that are developed elsewhere in Honeywell and brings them to the security business. Examples: video analysis software

**Support and the Best People:** Our employees are extraordinarily knowledgeable and experienced in security. They understand the industry and are dedicated to providing the best solution for our customers.

**The Power of Honeywell:** Honeywell is a \$37 billion dollar global company with the commitment, technology and the resources to provide the best security solution and to help our dealers and integrators grow.

# Hello Series Video Door Phone System

Simple design, big screen, Smile of Hello Phone lives with you every day, make your life more comfortable and convenient.



Honeywell Hello Series Video Door Phone System (HRPS) is based on RS485 BUS for data transmission, suitable for video door phone and emergency call in all kinds of residential community; System capability is over 40K units of color / B/W terminals, easy to install and maintain, high quality, good features and abundant functions with low price.

- Every call from resident is recorded in system, helps you get closer service;
- RS485 isolator makes stronger system, either for each unit or each floor;
- Audio sub phone, Max 5, broadcasting call;
- Emergency button interface;
- Bulletin board, Max 10 records in terminal (HRPS-1310).



## Hello Series Video Door Phone System Architecture

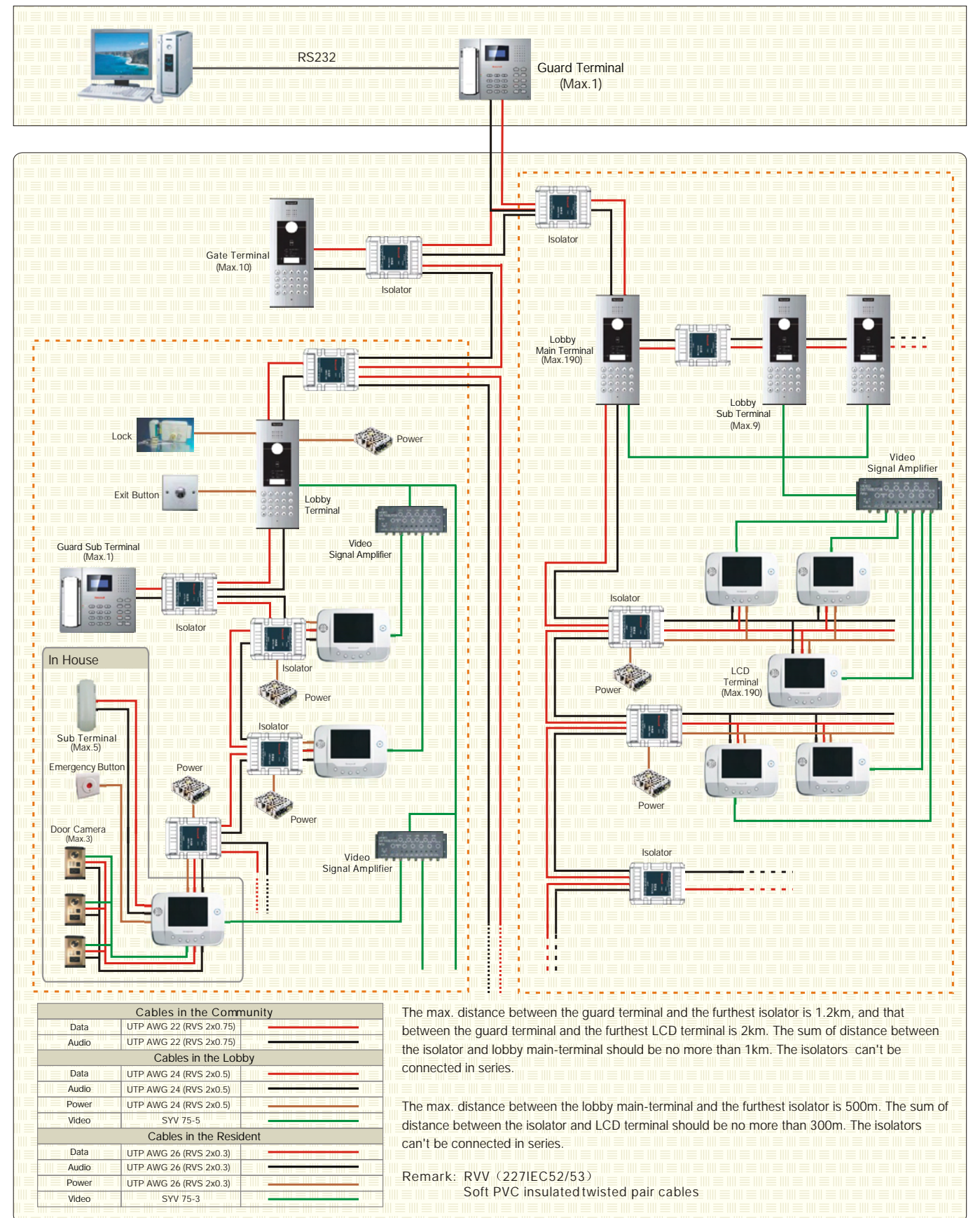

# Hello Series Video Door Phone System Architecture

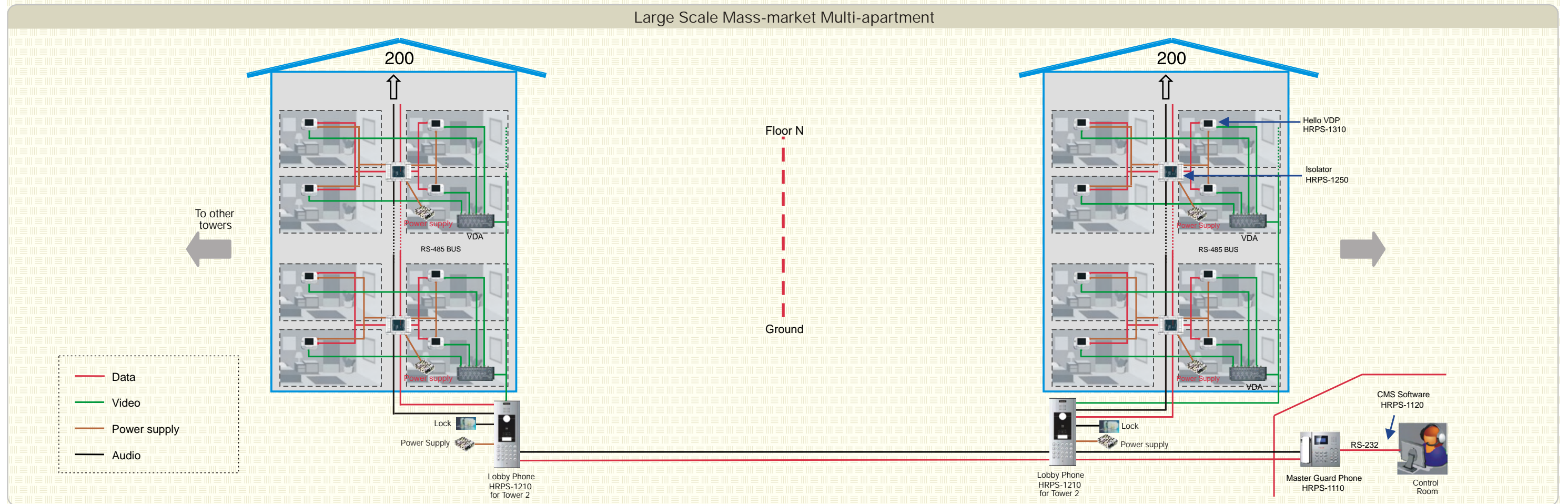
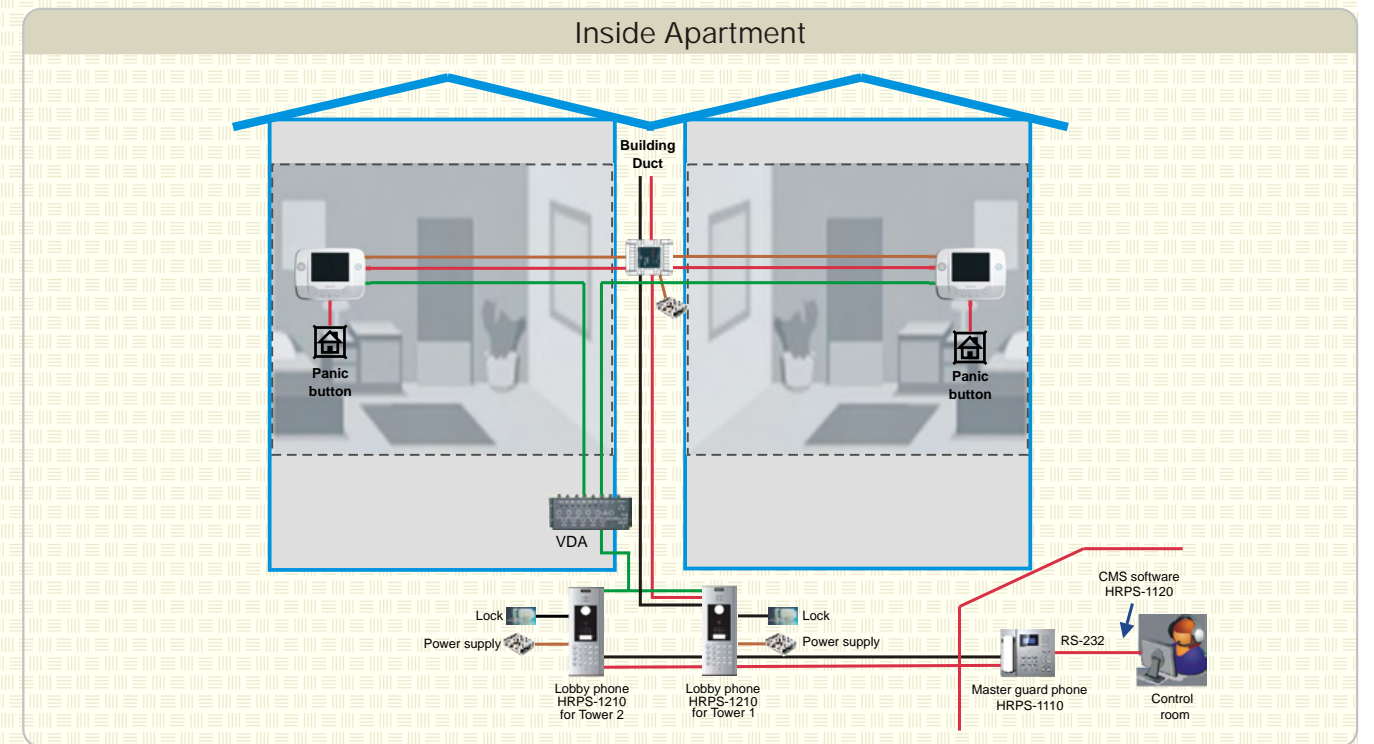
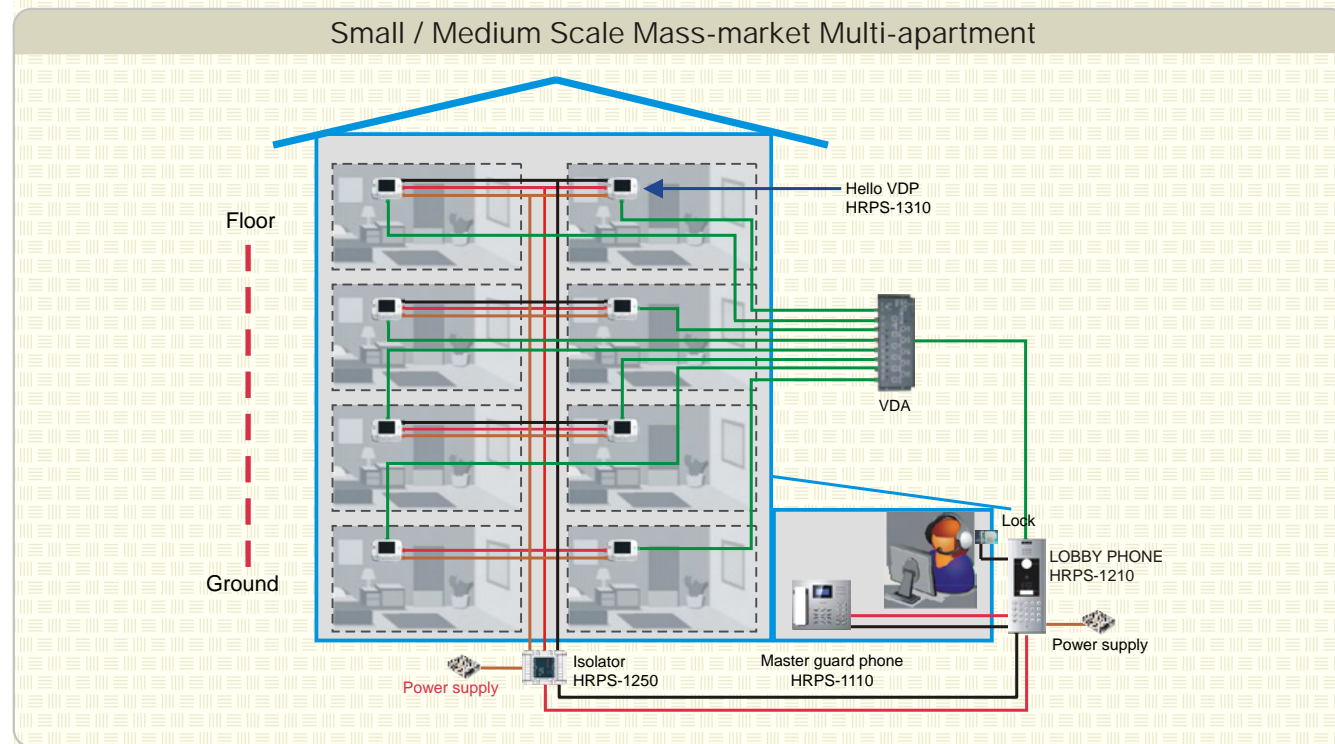

# Hello Series Video Door Phone System Architecture

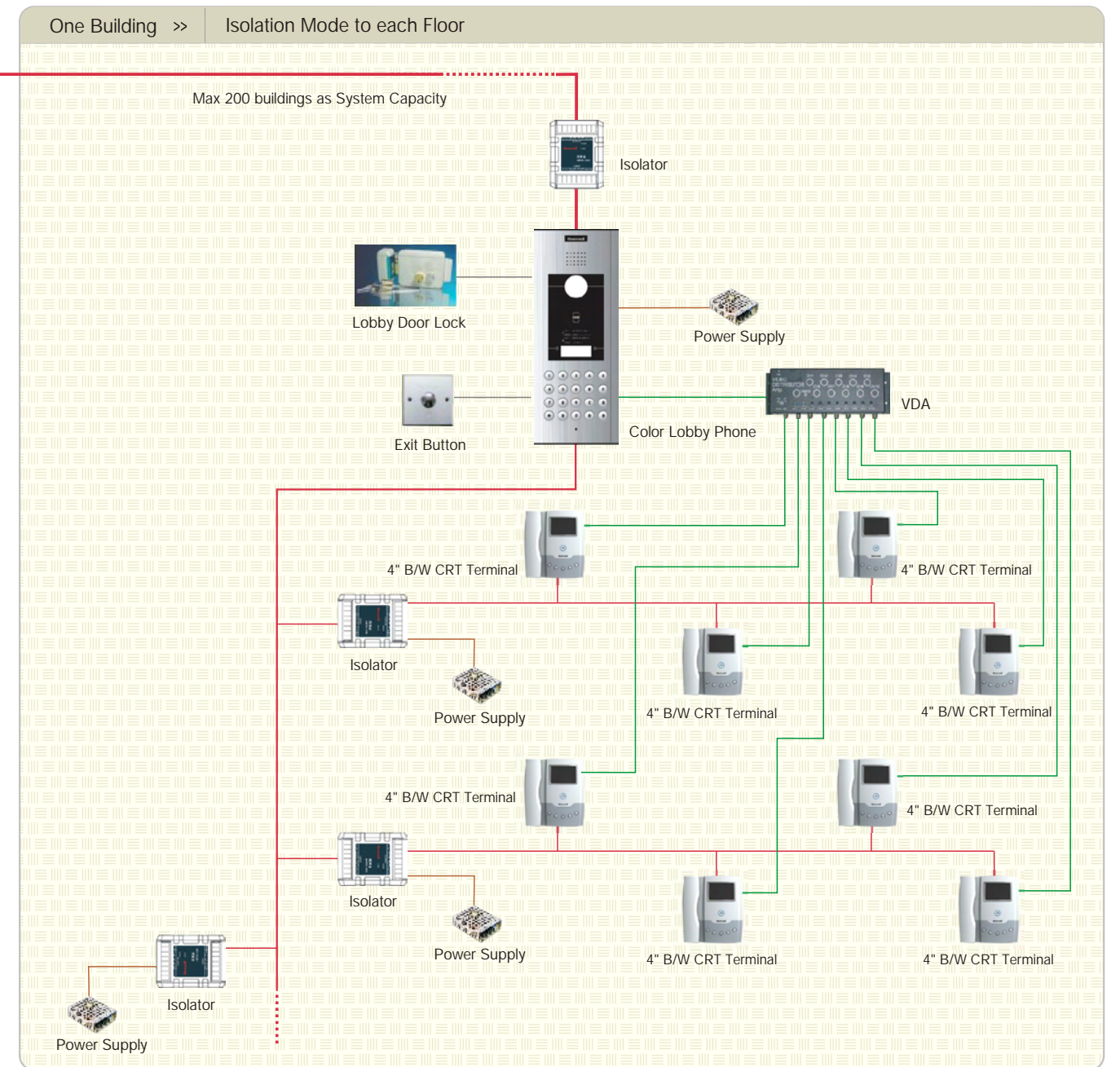
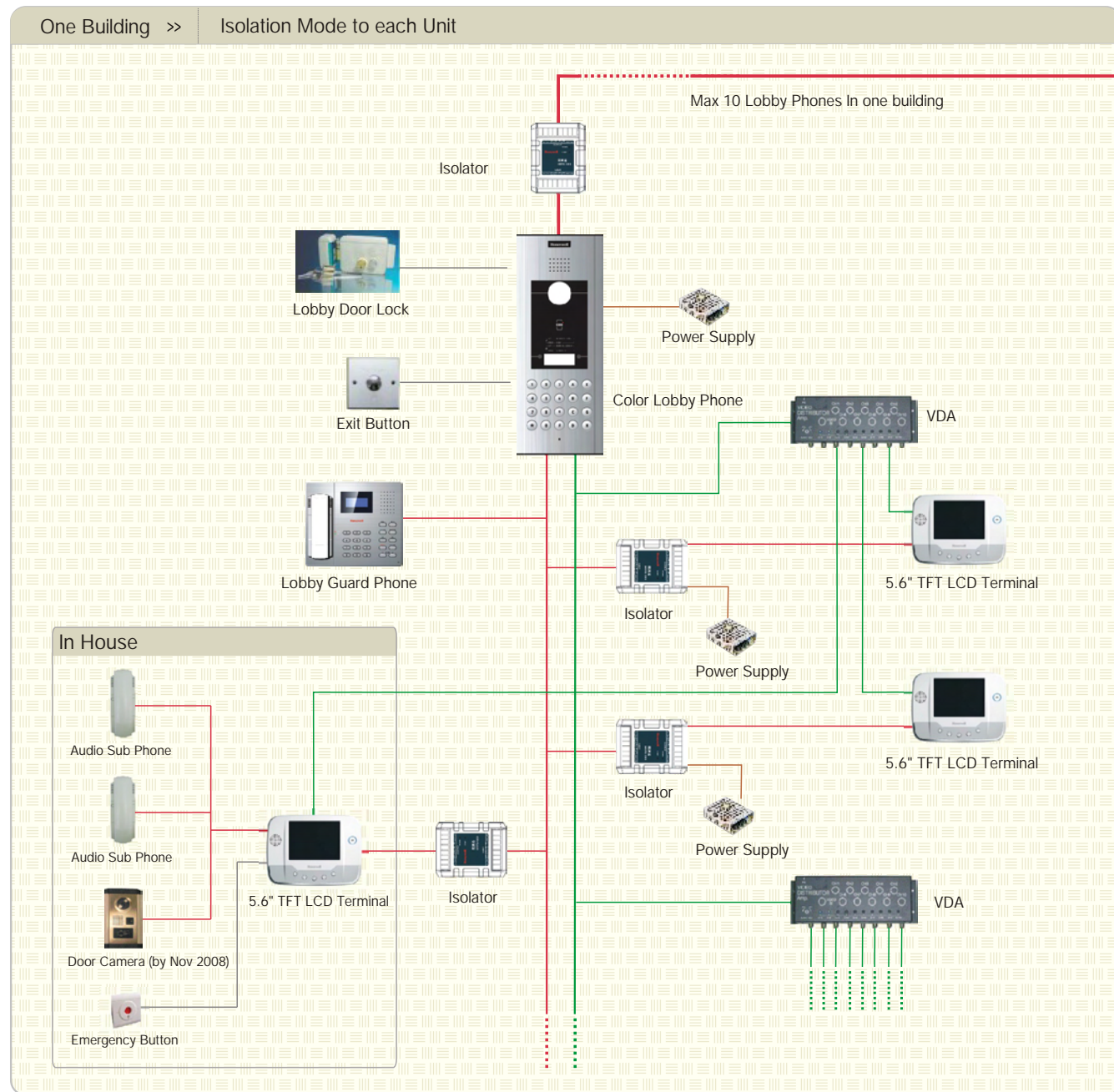
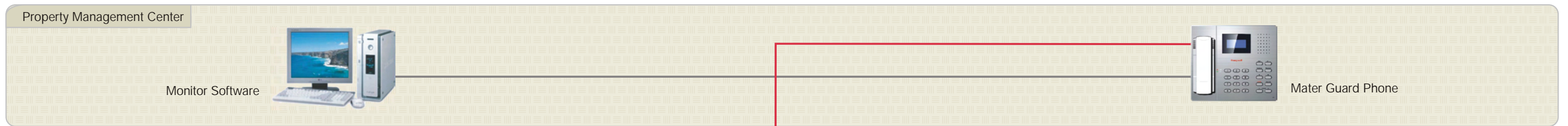

From Master Guard Phone to Lobby Phone  
 Audio: UTP AWG 22 (RVS 2x0.75)  
 Data: UTP AWG 22 (RVS 2x0.75)

From Lobby Phone to Unit  
 Audio: UTP AWG 24 (RVS 2x0.5)  
 Data: UTP AWG 24 (RVS 2x0.5)  
 Power Supply: UTP AWG 24 (RVS 2x0.5)  
 Video: SYV75-5

In House  
 Data/Audio/Power supply: UTP AWG 26 (RVS 2x0.3)  
 Video: SYV75-3

# Hello Series Video Door Phone System Product Description



## 5.6" TFT LCD TERMINAL (HRPS-1310)

### Major Functions

#### Communication

- Hand free talk
- Receive call from door camera, lobby phone with 3 melody options, talk and release door remotely
- Monitor door with door camera, lobby with lobby phone (one by one)
- Sub BUS inside to support audio sub phone, door camera
- Audio sub phone, up to 5, broadcasting call
- Door camera, up to 3
- 3 melody options: ding-dong tone, To Alice, Sweet Home
- Call between guard / management room
- Receive call from guard phone at unique ring
- Terminal indicates system busy when guard phone is busy, and call records inside guard phone and monitor software
- Music and LED flashing when receive call
- Or mute to keep silent call
- Talk time limitation, Max. 2 minutes

#### Interface

- Easy to operate with 6 buttons and menu
- Buttons with icon and voice
- Specific button to call guard
- Mute button
- English and Simplified Chinese language option in menu
- Bulletin board, up to 10 records in terminal
- Sound and LED flashing for incoming message
- Input for emergency button
- 3 relay output trigger (for door open, and interaction when emergency)
- Tamper switch
- Power supply switch
- 3 level volume adjustment switch
- Brightness, contrast, saturation adjustment in menu

#### Installation

- User mode and debug mode
- RS485 ID setup by keypad
- Wall mounting

### Specifications

- Communication protocol: RS-485
- BUS serial data communication (4,800 bps)
- Power supply: DC 15V
- Working Circuit: Max 500mA@15VDC
- Power Consumption: 7.5W (max)
- Display size: 5.6" color TFT LCD
- Resolution: 320(x 3) x 234
- Audio & Video: analog
- Operation type: button
- Indication: LED
- Audio distortion:  $\leq 5\%$
- Audio S/N:  $\geq 30\text{dB}$
- Working temperature:  $-10^{\circ}\text{C} \sim +55^{\circ}\text{C}$
- Working humidity:  $\leq 90\%$
- Dimensions (mm): 217.5(W) x 162(H) x 35(D)

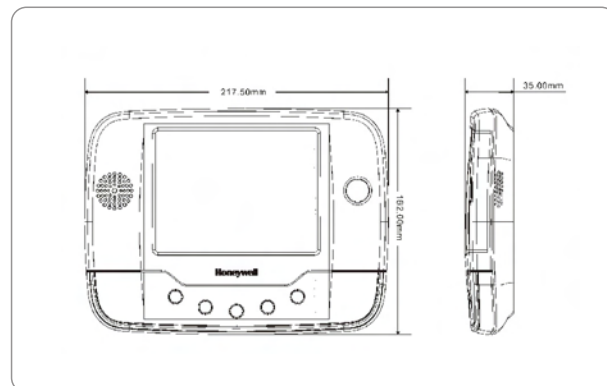

## 4" B/W CRT TERMINAL (HRPS-1320)

### Major Functions

#### Communication

- Handset talk
- Receive call from door camera, lobby phone with 3 melody options, talk and release door remotely
- Monitor door with door camera, lobby with lobby phone (one by one)
- Sub BUS inside to support audio sub phone, door camera
- Audio sub phone, up to 5, broadcasting call
- Door camera, up to 3
- 3 melody options: ding-dong tone, To Alice, Sweet Home
- Call between guard / management room
- Receive call from guard phone at unique ring
- Call records inside guard phone and monitor software when guard phone is busy
- Mute option to keep silent call
- Talk time limitation, Max. 2 minutes

#### Interface

- Easy to operate with 5 buttons
- Buttons with icon and prompt tone
- Specific button to call guard
- Mute button
- Input for emergency button
- 3 relay output trigger (for door open, and interaction when emergency)
- Tamper switch
- Power supply switch
- Volume adjustment switch
- Brightness, contrast adjustment switch

#### Installation

- User mode and debug mode
- RS485 ID setup by keypad
- Wall mounting

### Specifications

- Communication protocol: RS-485
- BUS serial data communication (4,800 bps)
- Power supply: DC 15V
- Display size: 4" B/W CRT
- Audio & Video: analog
- Operation type: button
- Indication: LED
- Audio distortion:  $\leq 5\%$
- Audio S/N:  $\geq 30\text{dB}$
- Working temperature:  $-10^{\circ}\text{C} \sim +55^{\circ}\text{C}$
- Working humidity:  $\leq 90\%$
- Dimensions (mm): 198(W) x 224(H) x 60(D)

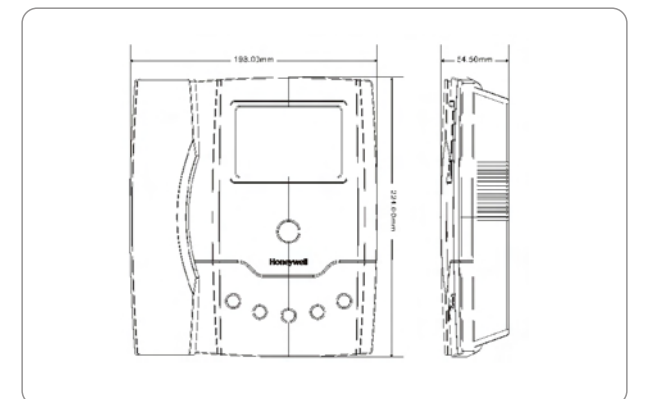

# Hello Series Video Door Phone System Product Description



## AUDIO SUB PHONE (HRPS-1330)

### Major Functions

- Communication
- Handset talk
  - Receive call from door camera, lobby phone, talk and release door remotely
  - Receive call from terminal
  - Call between guard / management room
  - Talk time limitation, Max. 2 minutes

### Interface

- Easy to operate with 2 buttons, door open and guard call
- Emergency call, long click guard call button when put off

### Installation

- RS485 ID setup by keypad
- Wall mounting

### Specifications

- Communication protocol: RS-485
- BUS serial data communication (4,800 bps)
- Power supply: DC 15V
- Working Circuit: Max 200mA@15VDC
- Power Consumption: 0.3W (max)
- Audio: analog
- Operation type: button
- Audio distortion:  $\leq 5\%$
- Audio S/N:  $\geq 30\text{dB}$
- Working temperature:  $-10^{\circ}\text{C} \sim +55^{\circ}\text{C}$
- Working humidity:  $\leq 90\%$
- Dimensions (mm): 76(W) x 220(H) x 43(D)



## COLOR LOBBY PHONE (HRPS-1210)

### Major Functions

- Communication
- Hand free talk
  - Call to terminals and talk with video, up to 200 units
  - Call to guard phone

### Interface

- 1/4" color CCD embedded, infrared LED as light compensation
- 4 bit LED display
- Digital keypad, 0-9, \*, #, A-H with night light
- Private and administrator password, 6 bits
- Mifare card reader embedded, up to 3000 cards
- Real time clock display
- Tamper switch

### Installation

- User mode and debug mode
- Self monitoring
- Options as lobby phone, sub lobby phone (up to 10 in one lobby), entrance phone (no video signal)
- Options as standalone, networked in one system

### Specifications

- Communication protocol: RS-485 BUS serial data communication (4,800 bps)
- Power supply: DC 15V
- Working Circuit: Max 500mA@15VDC
- Power Consumption: 7.5W (max)
- CCD: 1/4" color CCD
- CCD Resolution:  $\geq 380$  lines
- Card reader: 13.56MHz, Mifare card reader
- Card capacity: 3000 cards
- Card reader distance:  $< 5$  cm
- Waterproof and dustproof: IP33
- Audio & Video: analog
- Operation type: button
- Indication: LED
- Audio distortion:  $\leq 5\%$
- Audio S/N:  $\geq 30\text{dB}$
- Working temperature:  $-25^{\circ}\text{C} \sim +55^{\circ}\text{C}$
- Working humidity:  $\leq 90\%$
- Dimensions (mm): 366(W) x 140(H) x 50(D)

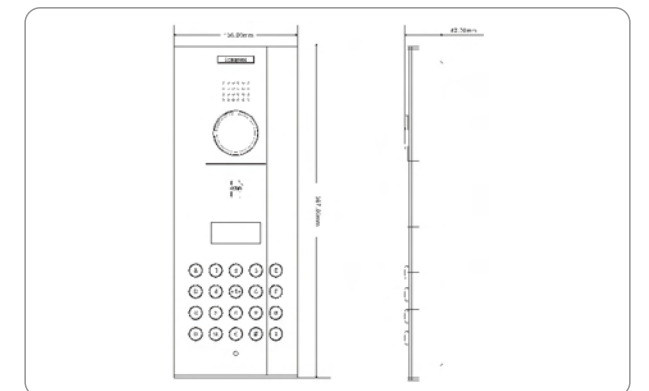

# Hello Series Video Door Phone System Product Description

## GUARD PHONE (HRPS-1110)



### Major Functions

#### Communication

- Call between terminals, sub phone
- Receive call from lobby phone, talk and release door remotely
- Up to 200 lobbies as master guard phone

#### Interface

- 128x64 yellow-green LCD display
- Real time clock display
- Auto save all call events, including address, time and date, memory up to 30 records, 10 each for answered call, non answered call, dialed call
- Receive and save emergency events, up to 30 records, including event address, time and date
- 2 RS232 serial ports, 1 for communication with monitor software in Server, records backup in monitor software; 2 for interconnection to other device
- English and Simplified Chinese language option in menu

#### Installation

- User mode and debug mode
- Options as mater guard phone, lobby guard phone

### Specifications

- Communication protocol: RS-485
- BUS serial data communication (4,800 bps)
- Power supply: AC 110V~240V
- Display size (mm): 70 x 40, yellow-green LCD
- Resolution: 128 x 64
- Audio: analog
- Operation type: button
- Indication: LED
- Audio distortion: ≤5%
- Audio S/N: ≥30dB
- Working temperature: -10°C ~ +55°C
- Working humidity: ≤90%
- Dimensions (mm): 312(W) x 272(H) x 120(D)

## ISOLATOR (HRPS-1250)

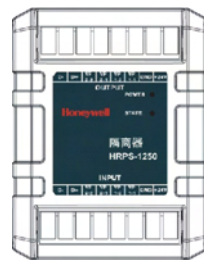

### Major Functions

- RS485 BUS isolation and protection with extension
- Audio isolation and protection
- Power supply protection
- VDA (Video Distribution Amplifier) is required
- Options used to each unit or each floor

### Specifications

- Communication protocol: RS-485
- BUS serial data communication (4,800 bps)
- Power supply: DC 15V
- Working Circuit: Max 45mA@15VDC
- Power Consumption: 0.7 W(max)
- Indication: LED
- Working temperature: -25°C ~ +55°C
- Working humidity: ≤90%
- Dimensions (mm): 120(W) x 92(H) x 30(D)

# Recommended Configuration

## Hello Series Video Door Phone System Configuration List

Product Name	Product Photo	Model No	Qty	Description
5.6" TFT LCD TERMINAL		HRPS-1310	N	Up to 200 units in one lobby
4" B/W CRT TERMINAL		HRPS-1320	N	Up to 200 units in one lobby
AUDIO SUB PHONE		HRPS-1330	N	Up to 5 audio sub phones in one house
COLOR LOBBY PHONE		HRPS-1210	N	Up to 200 lobbies in one system
VDA (VIDEO DISTRIBUTION AMPLIFIER)		Standard device (Outsource)	N	1 channel input, 8 channel outputs, standard outsource device
ISOLATOR		HRPS-1250	N	Options used to each unit or each floor
POWER SUPPLY		Standard device (Outsource)	N	Standard outsource device
GUARD PHONE		HRPS-1110	1	One master guard phone in one system
MONITOR SOFTWARE		HRPS-1120	1	
MIFARE CARD REGISTER		HRPS-1130	1	